

# 323E L/LN

Hydraulic Excavator



## Engine

Engine Model	Cat® C6.6 ACERT™
Engine Rated Power – ISO 9249 (metric)	114 kW (155 hp)

## Drive

Maximum Travel Speed	5.6 km/h
Maximum Drawbar Pull	205 kN

## Weights

323E L:	
Minimum Weight	22 900 kg
Maximum Weight	25 200 kg
323E LN:	
Minimum Weight	23 280 kg
Maximum Weight	24 230 kg



## Introduction

Since its introduction in the 1990s, the 300 Series family of excavators has become the industry standard in general, quarry, and heavy construction applications. The all-new E Series and the 323E will continue that trend-setting standard.

The 323E meets today's European Union emission standards. It is also built with several new fuel-saving and comfort-enabling features and benefits that will delight owners and operators.

If you are looking for more productivity and comfort, less fuel consumption and emissions, and easier and more sensible serviceability, you will find it in the all-new 323E and the E Series family of excavators.

## Contents

Engine .....	4
Operator Station.....	5
Hydraulics .....	6
Structures & Undercarriage .....	7
Front Linkage .....	8
Serviceability .....	9
Work Tools.....	10
Integrated Technologies.....	12
Safety .....	14
Complete Customer Care.....	15
Sustainability .....	16
Specifications.....	17
Standard Equipment.....	34
Optional Equipment.....	35







**With more productivity and comfort, less fuel consumption and emissions, and easier and more sensible serviceability, the 323E and the E Series family of excavators is ideal for improving your job site efficiency through low owning and operating costs, excellent performance and high versatility.**

# Engine

Reduced emissions, economical and reliable performance



## Cat C6.6 ACERT Engine

The Cat C6.6 ACERT engine delivers more horsepower using significantly less fuel than the previous series engine.

## Emissions Solution

Equipped to meet Stage IIIB emission standards, the 323E's C6.6 ACERT engine features wall and thru flow filters that perform through the machine work cycle without operator intervention.

All nonroad European Union Stage IIIB diesel engines are required to use only Ultra Low Sulfur Diesel (ULSD) fuels containing 15 mg/kg sulfur or less. Cat DEO-ULS™ or oils that meet the Cat ECF-3, API CJ-4, and ACEA E9 specification are also required. For further fluid specifications and guidelines, visit: <http://www.cat.com/cda/files/214956/7/SEBU6251-13-secured.pdf>

## Biodiesel-Ready Fuel System

The C6.6 ACERT engine is equipped with an electronic-controlled high-pressure fuel system that includes an electric priming pump (lifting pump) and three-layer fuel hoses to allow the use of biodiesels up to B20 (biodiesel fuel 20% mixture meeting ASTM 6751 or EN 14214).

## Cooling System

The cooling system features movable A/C condenser and ATAAC (Air To Air After Cooler) for easy cleaning; the fan automatically adjusts to ambient temperatures to help reduce fuel consumption and noise.

## Speed and Power Control

The 323E features speed control to maintain a constant speed – regardless of load – to improve fuel economy. Three different power modes are offered: high power, standard power, and economy power. The operator can easily change between modes through the monitor or console switch to meet the needs for the job at hand – all to help manage and conserve fuel.



# Operator Station

Comfort and convenience to keep people productive



## Seats

The seat range includes air suspension, heated, and air cooled options. All seats include a reclining back, upper and lower seat slide adjustments, and height and tilt angle adjustments to meet operator needs for comfort and productivity.

## Controls

The right and left joystick consoles can be adjusted to meet individual preferences, improving operator comfort and productivity during the course of a day. With the touch of a button, one-touch idle reduces engine speed to help save fuel; touch it again or move the joystick and the machine returns to normal operating level. The heavy lift mode increases machine system pressure to improve lift – a nice benefit in lift applications.

## Monitor

A 7" LCD (Liquid Crystal Display) monitor is 40% bigger than the previous model's with higher resolution for better visibility. An improved keypad with added functionality, is programmable to provide information in 42 languages to support today's diverse workforce.

An "Engine Shutdown Setting" accessible through the monitor allows owners and operators to specify how long the machine should idle before shutting down the engine, which can save significant amounts of fuel. The rearview camera image is displayed directly on the monitor; two different camera images can also be displayed on the screen at the same time.

## Power Supply

Two 12-volt power supply sockets are located near key storage areas for charging electronic devices.

## Storage

Storage spaces are located in the front, rear, and side consoles. A specific space near the auxiliary power supply holds MP3 players and cell phones. The drink holder accommodates large mugs with handles, and a shelf behind the seat stores large lunch or toolboxes.

## Automatic Climate Control

The climate control system features five air outlets with positive filtered ventilation, which makes working in the heat and cold much more pleasant.

# Hydraulics

Power to move more dirt, rock, and debris with speed and precision



## Main Control Valve and Auxiliary Valves

The 323E uses a high-pressure system to tackle the toughest of work in short order. The machine features a highly efficient and simple back-to-back main control valve to improve fuel consumption; it also allows for greater tool versatility.

## Swing Priority Circuit

The swing priority circuit on the 323E uses an electric valve that's operated by the machine's Electronic Control Module (ECM). Compared to using a hydraulic valve, an electric valve allows for more finely tuned control, which is critical during material loading.

## SmartBoom™

SmartBoom reduces stress and vibrations transmitted to the machine and provides a more comfortable environment. It is particularly well suited for certain applications:

- **Rock scraping.** SmartBoom simplifies the task and allows the operator to concentrate on stick and bucket while the boom freely goes up and down without using pump flow.
- **Hammer work.** The front parts automatically follow the hammer while penetrating the rock. Blank shots or excessive force on the hammer are avoided, resulting in longer life for the hammer and the machine.

## Electric Boom Regeneration Valve

This valve minimizes pump flow when the boom lowers down, which helps improve fuel efficiency. It is optimized for any dial speed setting being used by the operator, which results in optimized boom lowering speed for higher controllability.





## Structures & Undercarriage

Built to work in rugged environments



### Frame

The upper frame includes reinforced mountings to support the Roll-Over Protective Structure (ROPS) cab; the lower frame is reinforced to increase component durability.

### Undercarriage

Fixed gauge long and long narrow undercarriage systems are available to support various work applications.

A segmented two-piece guiding guard is now offered to help maintain track alignment and improve performance in multiple applications.

### Counterweights

The machine comes equipped with a 4.1 mt counterweight (323E L) or a 4.4 mt counterweight for the 323E LN, both with integrated rearview camera housing. The counterweight also features integrated links to enable easy removal for maintenance or shipping.

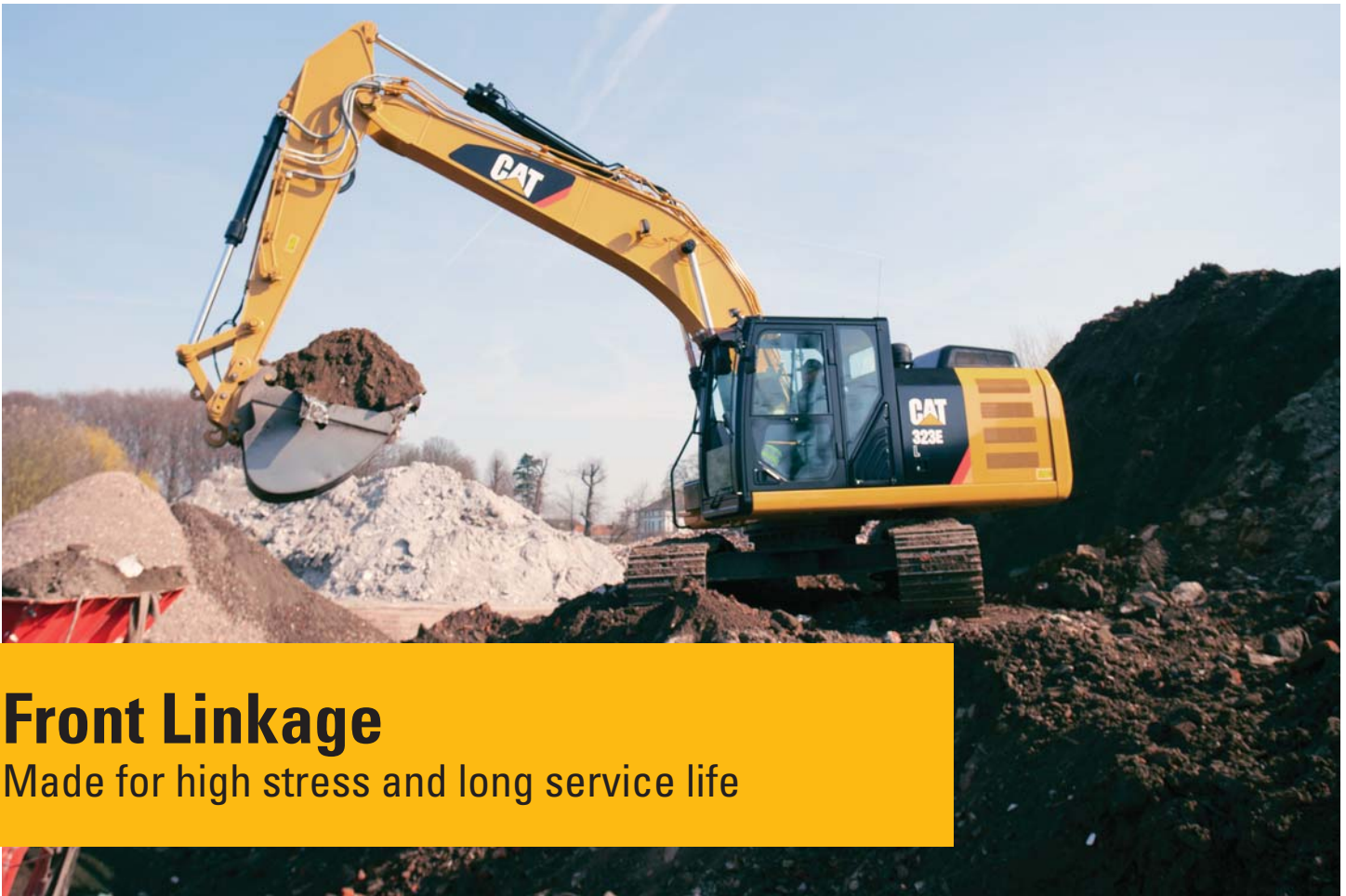

## Front Linkage

Made for high stress and long service life

### Booms and Sticks

The 323E is offered with a range of booms and sticks. Each is built with internal baffle plates for added durability, and each undergoes ultrasound inspection to ensure weld quality and reliability.

Large box-section structures with thick, multi-plate fabrications, castings, and forgings are used in high-stress areas such as the boom nose, boom foot, boom cylinder, and stick foot to improve durability.

The boom nose pin retention method is a durable captured flag design. Boom durability is improved with a number of plate thickness changes. Also, the front linkage pins' inner bearing surfaces are welded, and a self-lubricated bearing is used to extend service intervals and increase uptime.

### Selections

There are three basic boom options: HD, ES, and VA. Sticks match the boom descriptions and applications below:

- **HD = Heavy Duty** – This boom is designed to balance reach, digging force, and bucket capacity. It covers the vast majority of applications such as digging, loading, trenching, and working with hydraulic tools.
- **ES = Extreme Service** – This configuration will do multipurpose digging and loading, but its added weight makes it more durable and better suited for highly demanding applications. The bucket and tool matching guides help identify which conditions require the ES front.
- **VA = Variable Angle** – This configuration offers superb flexibility and versatility in the working envelope. Boom position can be adjusted from 90° when fully retracted to 180° and fully extended. With full extension, the working range gives maximum dig depth, reach, and working height. Equally, when retracted, it can work closer to its tracks, increase lifting capacity, and work in confined areas.



# Serviceability

Fast, easy and safe access built in



## Service Doors

Wide service doors and a one-piece hood provide easy access to the engine and cooling compartments. Both doors and hood feature enhanced hardware and a new screen design to help minimize debris entry.

## Compartments

The radiator, pump, and air cleaner compartments provide easy access to major components. The fresh air filter is located on the side of the cab to make it easy to reach and replace as needed.

## Maintenance

Tilt-up ATAAC and swing out A/C condenser for easy cleaning.

## Other Service Benefits

The water separator with water level sensor has a primary fuel filter element located in the pump compartment near ground level; the electric priming pump (lifting pump) is mounted before the primary filter.

The fuel tank features a remote drain cock located in the pump compartment to make it easy to remove water and sediment during maintenance.

The engine oil check gauge is situated in front of the engine compartment for easy access, and a uniquely designed drain cock helps prevent spills. The engine oil filter is located in the pump compartment.

The hydraulic valve lush located on the engine valve does not need maintenance.



# Work Tools

Dig, hammer, rip, and cut with confidence



An extensive range of Cat Work Tools for the 323E includes buckets, compactors, grapples, multi-processors, scrap and demolition shears, rippers, crushers, pulverizers, hammers, and shears. Each is designed to optimize the versatility and performance of your machine.

## CW Quick Couplers

Quick couplers allow one person to change work tools in seconds for maximum performance and flexibility on a job site. One machine can move rapidly from task to task, and a fleet of similarly equipped machines can share a common work tool inventory. The dedicated CW Series quick coupler enables a quick tool exchange while maintaining top machine performance. A lifting hook is added for maximum lift capacity.

The CW quick coupler can pick up any work tool and is equipped with a wedge-style locking system that fits the quick coupler tight to the tool hinges. Due to the tapered wedge design, there won't be any play during its entire life. Also, it is interchangeable with different machine classes. The CW is highly suitable for harsh applications such as demolition and quarries.



## Buckets

Cat buckets are designed as an integral part of the 323E system and feature new geometry for better performance. The leading edge has been pushed forward, resulting in more efficient filling and better operator control for greatly improved productivity. Wear coverage in the corners and side cutter and sidebar protector coverage are improved. All benefits are captured in a new bucket line with a new bucket naming convention.

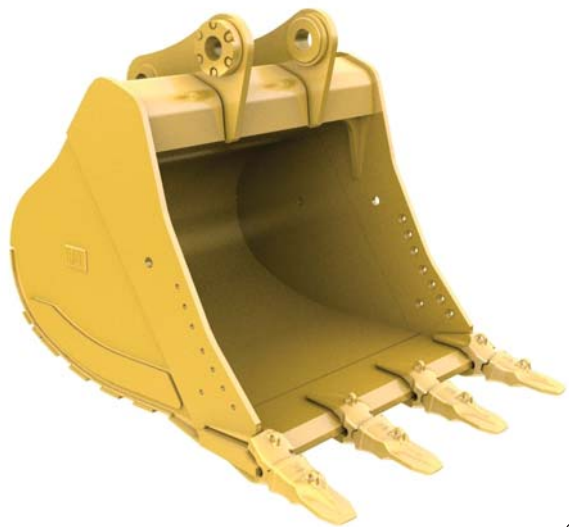

1

## Durability Categories Suitable for Any Situation

For the 323E excavator, Caterpillar offers three standard bucket durability categories for excavators. Each category is based on intended bucket durability when used in recommended application and material. Each bucket durability is available as pin-on or can be used with a Quick Coupler. Red areas on bucket images illustrate additional protection against wear as it increases across each category.

### General Duty (GD)

GD buckets are for digging in low-impact, low-abrasion material such as dirt, loam, and mixed compositions of dirt and fine gravel.

### Heavy Duty (HD)

The most popular bucket style, HD buckets are a good starting point when digging conditions are not well known like a wide range of impact and abrasion conditions that include mixed dirt, clay, and rock.

### Severe Duty (SD)

SD buckets are for higher abrasion conditions such as well shot granite and caliche.

### Special Buckets

Special buckets are available for the 323E on request.

### Comprehensive Product Support

All Cat Work Tools are backed up by a world-wide network of well-stocked parts depots and highly experienced service and support personnel.

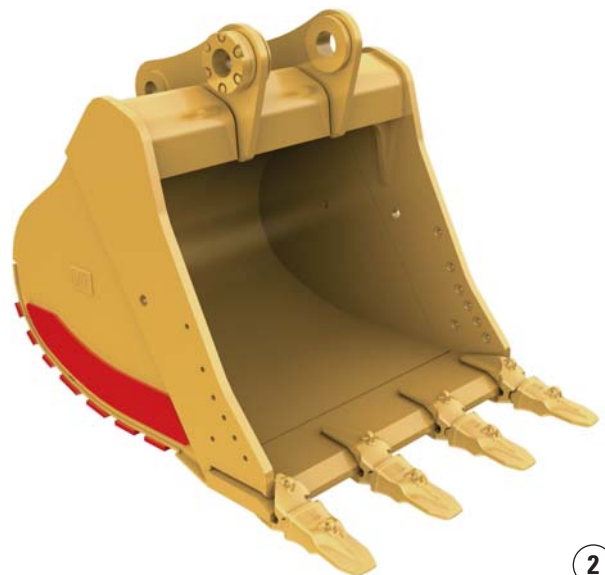

2

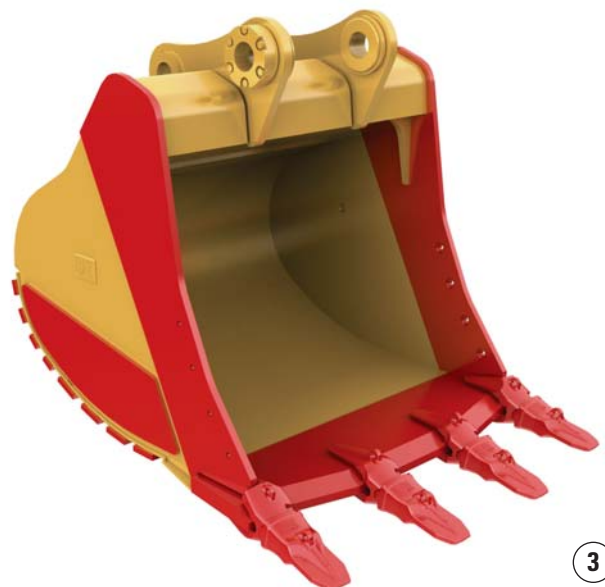

3

1) General Duty 2) Heavy Duty 3) Severe Duty

# Integrated Technologies

Monitor, manage, and enhance job site operations



CAT CONNECT makes smart use of technology and services to improve your job site efficiency. Using the data from technology-equipped machines, you'll get more information and insight into your equipment and operations than ever before.

Cat Connect technologies offers improvements in these key areas:



EQUIPMENT  
MANAGEMENT

**Equipment Management** – increase uptime and reduce operating costs.



PRODUCTIVITY

**Productivity** – monitor production and manage job site efficiency.



SAFETY

**Safety** – enhance job site awareness to keep your people and equipment safe.

## LINK Technologies

LINK technologies, like Product Link™, are deeply integrated into your machine and wirelessly communicates key information, including location, hours, fuel usage, idle time and event codes.

### Product Link™/VisionLink®

Easy access to Product Link data via the online VisionLink user interface can help you see how your machine or fleet is performing. You can use this information to make timely, fact based decisions that can boost job site efficiency and productivity, and lower costs.





## GRADE Technologies

Grade technologies combine digital design data and in-cab guidance to help you reach target grade quickly and accurately, with minimal staking and checking. That means you'll be more productive, complete jobs faster, in fewer passes, using less fuel, at a lower cost.

### Cat Grade Control Depth and Slope

The factory integrated Cat Grade Control system delivers 2D bucket tip elevation guidance to the cab to help operators create precise planes and slopes with ease. Real-time bucket tip elevation guidance on the easy-to-read standard cab monitor indicates how much to cut or fill. Fast response sensors deliver immediate feedback, while optional integrated joystick buttons help operators make quick adjustments to maintain consistent, quality grades. Built-in alerts can be set to warn the operator if the linkage or bucket approaches a predefined elevation or depth, such as when working in areas with low ceilings, or digging near water lines. Staking and checking is minimized, which reduces ground crews and enhances job site safety.

Works best in simple 2D applications, such as digging basements or grading steep embankments. Easily upgrade to AccuGrade™ when 3D control is required.

### Cat AccuGrade™

The dealer-installed AccuGrade system provides 3D guidance for making complex cuts and contours, eliminating the need for staking and checking. A dedicated monitor displays a digital design plan with 3D bucket tip positioning and elevation guidance, indicating precisely where to work and how much to cut or fill.

Plug and play capability on the 323E simplifies upgrading. Choose from satellite (GNSS) control for large projects with complex designs or total station (UTS) systems in areas with limited reception



# Safety

Features to help protect people

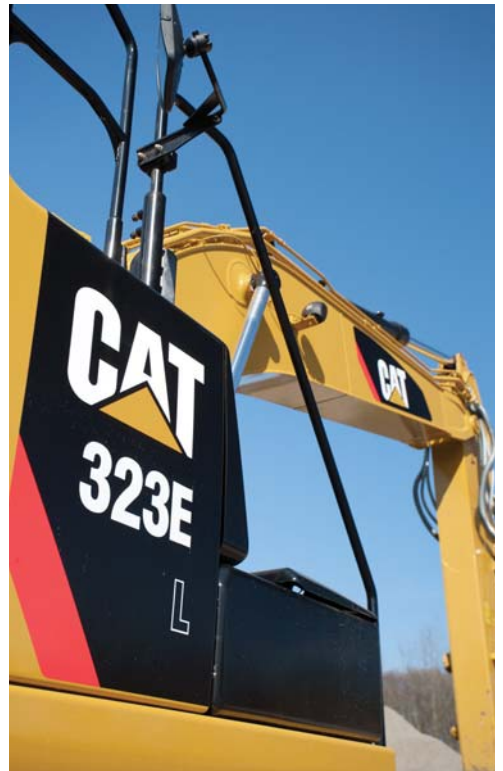

## **ROPS Cab (ISO 12117)**

The ROPS-certified cab allows a Falling Object Guard Structure (FOGS) to be bolted directly to it.

## **Sound Proofing**

Improved sealing and cab roof lining lower noise levels inside the cab significantly during machine operation (-5 dB).

## **Anti-Skid Plates**

The surface of the upper structure and the top of the storage box area are covered with anti-skid plates to help prevent service personnel and operators from slipping during maintenance.

## **Steps, Hand and Guard Rails (ISO 2867)**

Steps on the track frame and storage box along with extended hand and guard rails (2) to the upper deck enable operators to securely work on the machine.

## **Time Delay Lights**

After the engine start key has been turned to the "OFF" position, cab and boom lights will illuminate to enhance visibility. The time delay can vary from 0 to 90 seconds, which can be set through the cab monitor.

## **High Intensity Discharge (HID) Lights**

Halogen lights are standard, but they can be upgraded to HID for greater visibility.

## **Visibility – Windows**

Two windshield options are available: The 70/30 split windshield configuration features an upper window equipped with handles on the top and both sides so the operator can slide it to store in the ceiling. The lower window is removable and can be stored on the left wall of the cab shell. A one-piece fixed front windshield provides operators an unobstructed forward view.

The large skylight provides great overhead visibility, excellent natural lighting, and good ventilation. The skylight can be opened completely to become an emergency exit.

## **Monitor Warning System**

The monitor is equipped with a buzzer that can warn operators of critical events so they can take any necessary action.

## **Rearview Camera and Mirrors (ISO 5006)**

The standard rearview camera is housed in the counterweight. The image projects through the cab monitor to give the operator a clear view of what is behind the machine. The mirrors and rearview camera are designed to meet visibility regulations.





## Complete Customer Care

Service you can count on

### Product Support

Cat dealers utilize a worldwide parts network to maximize your machines' uptime. Plus they can help you save money with Cat remanufactured components.

### Machine Selection

What are the job requirements and machine attachments? What production is needed? Your Cat dealer can provide recommendations to help you make the right machine choices.

### Purchase

Consider financing options and day-to-day operating costs. Look at dealer services that can be included in the machine's cost to yield lower owning and operating costs over time.

### Customer Support Agreements

Cat dealers offer a variety of customer support agreements and work with you to develop a plan to meet your specific needs. These plans can cover the entire machine, including attachments, to help protect your investment.

### Operation

Improving operating techniques can boost your profits. Your Cat dealer has videos, literature, and other ideas to help you increase productivity. Caterpillar also offers simulators and certified operator training to help maximize the return on your investment.

### Replacement

Repair, rebuild, or replace? Your Cat dealer can help you evaluate the cost involved so you can make the best choice for your business.

# Sustainability

Generations ahead in every way



- The C6.6 ACERT engine, along with the Cat Clean Emissions Module (CEM), meets EU Stage IIIB emission standards.
- Even when operating in high horsepower and high production applications, the 323E performs a similar amount of work while burning up to 12% less fuel than the previous D Series model. This means more efficiency, less resources consumed, and fewer CO<sub>2</sub> emissions.
- The 323E has the flexibility of running on either ultra-low-sulfur diesel (ULSD) fuel with 15 mg/kg of sulfur or less or bio diesel (B20) fuel blended with ULSD.
- A ground-level overfill indicator rises when the hydraulic oil tank is full to help the operator avoid spilling.
- The QuickEvac™ feature ensures fast, easy, and secure changing of engine and hydraulic oil (323E L only).
- The 323E is built to be rebuilt with major structures and components capable of being remanufactured to reduce waste and replacement costs.
- An engine oil filter is designed so that it eliminates the need for painted metal cans and aluminum top plates. The cartridge-style spin-on housing enables the internal filter to be separated and replaced.
- The 323E is an efficient, productive machine that's designed to conserve our natural resources for generations ahead.





# 323E L/LN Hydraulic Excavator Specifications

## Engine

Engine Model	Cat C6.6 ACERT
Power – ISO 14396	121 kW
Power – ISO 14396 (metric)	165 hp
Power – ISO 14396 (imperial)	162 hp
Net Power – ISO 9249 (metric)	114 kW
Net Power – ISO 9249 (metric)	155 hp
Net Power – ISO 9249 (imperial)	153 hp
Bore	105 mm
Stroke	127 mm
Displacement	6.6 L

## Weights

323E L:	
Minimum Weight	22 900 kg
Maximum Weight	25 200 kg
323E LN:	
Minimum Weight	23 280 kg
Maximum Weight	24 230 kg

## Hydraulic System

Main System – Maximum Flow (Total)	428 L/min
Swing System – Maximum Flow	214 L/min
Maximum Pressure – Equipment	35 000/38 000 kPa
Maximum Pressure – Travel	35 000 kPa
Maximum Pressure – Swing	25 000 kPa
Pilot System – Maximum Flow	24.3 L/min
Pilot System – Maximum Pressure	3920 kPa
Boom Cylinder – Bore	120 mm
Boom Cylinder – Stroke	1260 mm
Stick Cylinder – Bore	140 mm
Stick Cylinder – Stroke	1504 mm
B1 Bucket Cylinder – Bore	120 mm
B1 Bucket Cylinder – Stroke	1104 mm

## Drive

Maximum Travel Speed	5.6 km/h
Maximum Drawbar Pull	205 kN
Gradeability	35°/70%

## Swing Mechanism

Swing Speed	11.2 rpm
Swing Torque	61.8 kN·m

## Service Refill Capacities (323E L)

Fuel Tank Capacity	410 L
Cooling System	30 L
Engine Oil (with filter)	23 L
Swing Drive	8 L
Final Drive (each)	8 L
Hydraulic System Oil Capacity (including tank)	260 L
Hydraulic Tank Oil	159 L

## Service Refill Capacities (323E LN)

Fuel Tank Capacity	310 L
Cooling System	30 L
Engine Oil (with filter)	23 L
Swing Drive	8 L
Final Drive (each)	8 L
Hydraulic System Oil Capacity (including tank)	260 L
Hydraulic Tank Oil	153 L

## Track

Number of Shoes (each side)	
Long/Long Narrow Undercarriage	49 pieces
Number of Track Rollers (each side)	
Long/Long Narrow Undercarriage	8 pieces
Number of Carrier Rollers (each side)	
Long/Long Narrow Undercarriage	2 pieces

## Sound Performance

ISO 6396	
Operator Sound	71 dB(A)
ISO 6395	
Spectator Sound	103 dB(A)

- Operator Sound – The operator sound level is measured according to the procedures specified in ISO 6394:1998, for cab offered by Caterpillar, when properly installed and maintained and tested with doors and windows closed.
- Exterior Sound – The labeled spectator sound power level is measured according to the test procedures and conditions specified in 2004/14/EC.
- Hearing protection may be needed when operating with an open operator station and cab (when not properly maintained for doors/windows open) for extended periods or in a noisy environment.

## Standards

Brakes	ISO 10265 2008
Cab/FOGS	ISO 10262 1998
Cab/ROPS	ISO 12117-2 2008

# 323E L/LN Hydraulic Excavator Specifications

## 323E L Dimensions

All dimensions are approximate.

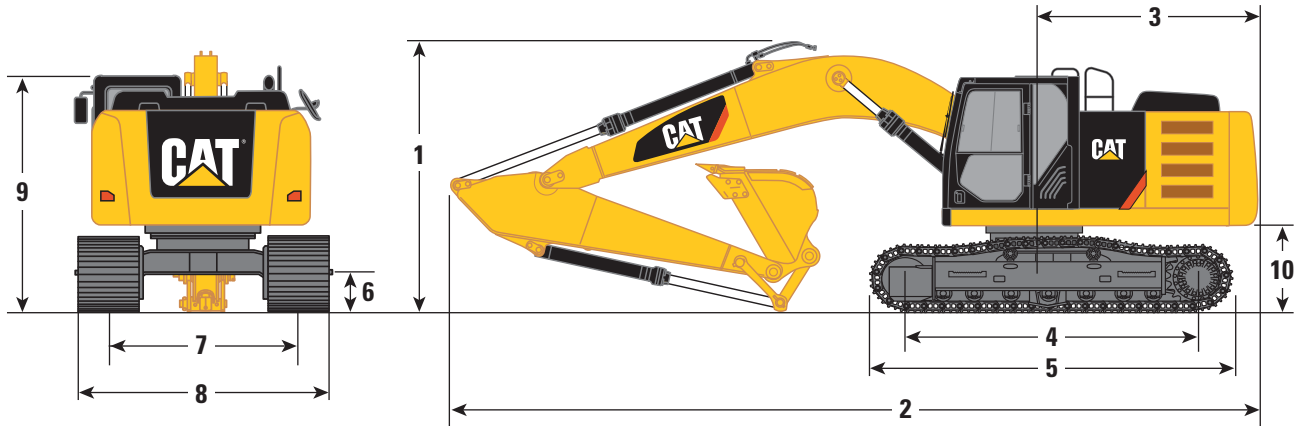

Stick	Reach Boom 5.7 m		VA Boom	
	R2.9B1	R2.5B1	R2.9B1	R2.5B1
<b>1</b> Shipping Height without Guard Rail*	3130 mm	3080 mm	2970 mm	3020 mm
Shipping Height with Guard Rail	3240 mm	3240 mm	3240 mm	3240 mm
Shipping Height with Top Guard, without Guard Rail	3150 mm	3150 mm	3150 mm	3150 mm
<b>2</b> Shipping Length	9540 mm	9570 mm	9780 mm	9820 mm
<b>3</b> Tail Swing Radius	2830 mm	2830 mm	2830 mm	2830 mm
<b>4</b> Length to Center of Rollers	3650 mm	3650 mm	3650 mm	3650 mm
<b>5</b> Track Length	4460 mm	4460 mm	4460 mm	4460 mm
<b>6</b> Ground Clearance	450 mm	450 mm	450 mm	450 mm
<b>7</b> Track Gauge	2380 mm	2380 mm	2380 mm	2380 mm
<b>8</b> Transport Width				
600 mm Shoes	2980 mm	2980 mm	2980 mm	2980 mm
700 mm Shoes	3080 mm	3080 mm	3080 mm	3080 mm
790 mm Shoes	3170 mm	3170 mm	3170 mm	3170 mm
900 mm Shoes	3280 mm	3280 mm	3280 mm	3280 mm
<b>9</b> Cab Height	2960 mm	2960 mm	2960 mm	2960 mm
Cab Height with Top Guard	3150 mm	3150 mm	3150 mm	3150 mm
<b>10</b> Counterweight Clearance**	1020 mm	1020 mm	1020 mm	1020 mm
Bucket Capacity	1.19 m <sup>3</sup>	1.3 m <sup>3</sup>	1.3 m <sup>3</sup>	1.3 m <sup>3</sup>
Bucket Tip Radius	1570 mm	1560 mm	1560 mm	1560 mm

\*Including shoe lug height.

\*\*Without shoe lug height.



# 323E L/LN Hydraulic Excavator Specifications

## 323E LN Dimensions

All dimensions are approximate.

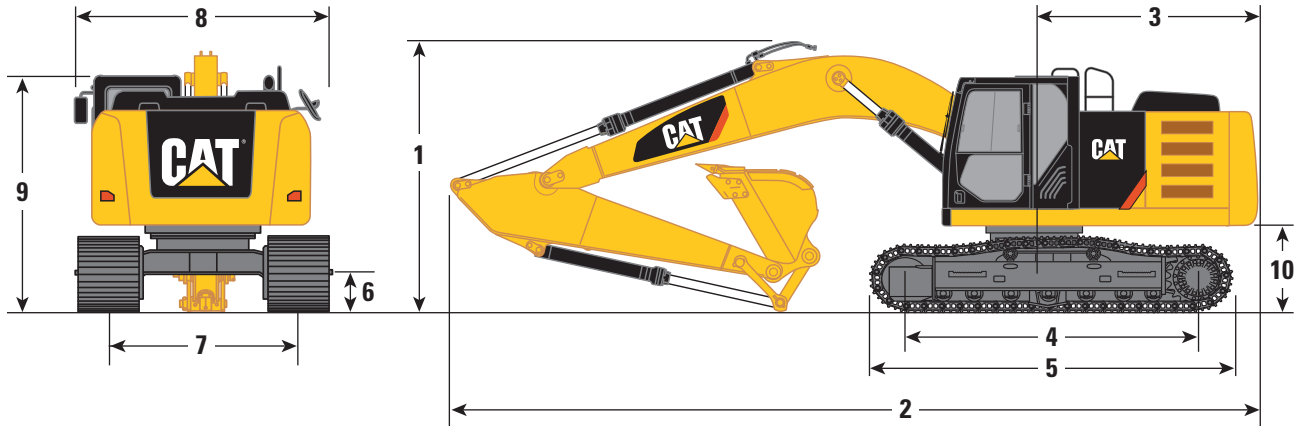

	Reach Boom 5.7 m			VA Boom
Stick	R2.9B1	R2.5B1	R1.9CB2	R2.5B1
<b>1</b> Shipping Height without Guard Rail*	3020 mm	3080 mm	3050 mm	3020 mm
Shipping Height with Guard Rail	3240 mm	3240 mm	3240 mm	3240 mm
Shipping Height with Top Guard, without Guard Rail	3150 mm	3150 mm	3150 mm	3150 mm
<b>2</b> Shipping Length	9560 mm	9570 mm	9460 mm	9820 mm
<b>3</b> Tail Swing Radius	2830 mm	2830 mm	2830 mm	2830 mm
<b>4</b> Length to Center of Rollers	3650 mm	3650 mm	3650 mm	3650 mm
<b>5</b> Track Length	4460 mm	4460 mm	4460 mm	4460 mm
<b>6</b> Ground Clearance	450 mm	450 mm	450 mm	450 mm
<b>7</b> Track Gauge	2000 mm	2000 mm	2000 mm	2000 mm
<b>8</b> Transport Width				
500 mm Shoes	2540 mm	2540 mm	2540 mm	2540 mm
<b>9</b> Cab Height	2960 mm	2960 mm	2960 mm	2960 mm
Cab Height with Top Guard	3150 mm	3150 mm	3150 mm	3150 mm
<b>10</b> Counterweight Clearance**	1020 mm	1020 mm	1020 mm	1020 mm
Bucket Capacity	1.3 m <sup>3</sup>	1.3 m <sup>3</sup>	1.3 m <sup>3</sup>	1.3 m <sup>3</sup>
Bucket Tip Radius	1560 mm	1560 mm	1620 mm	1560 mm

\*Including shoe lug height.

\*\*Without shoe lug height.

# 323E L/LN Hydraulic Excavator Specifications

## 323E L Working Ranges

All dimensions are approximate.

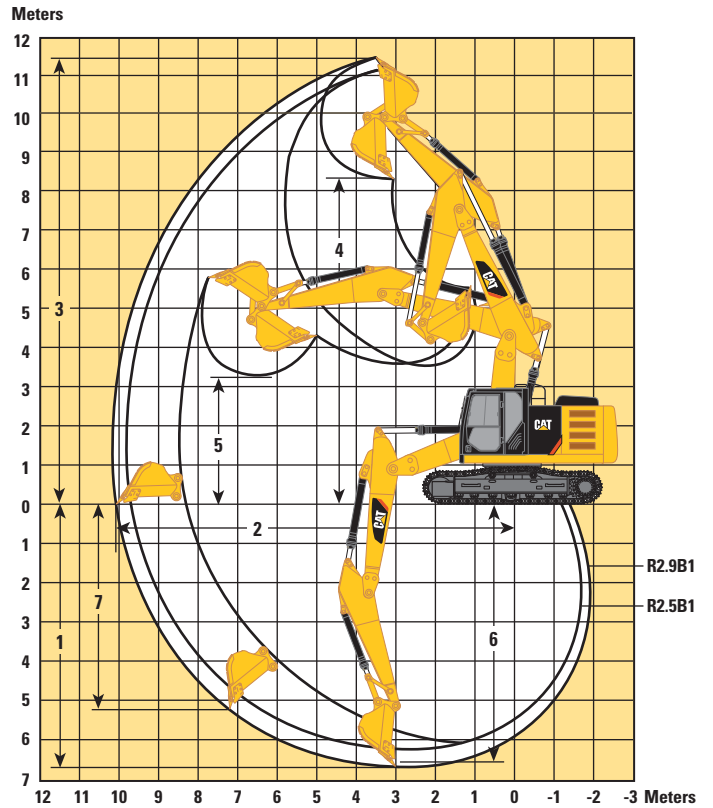
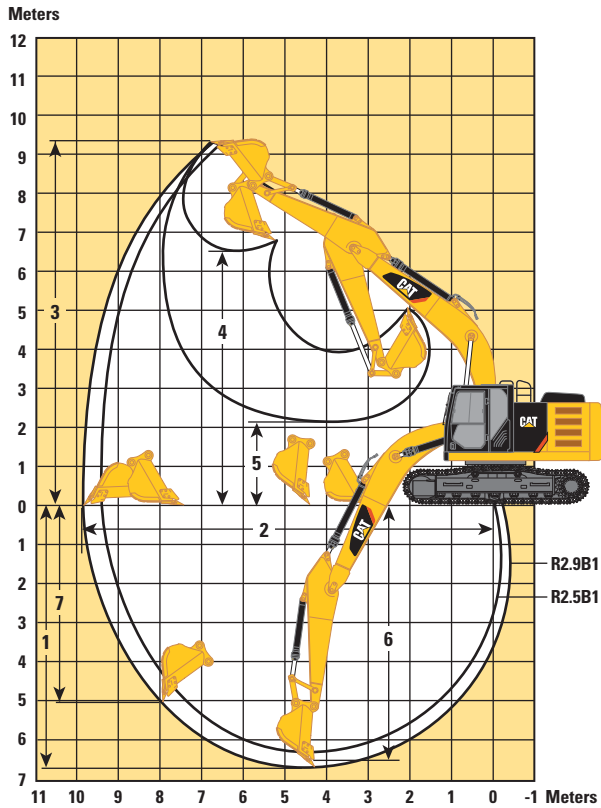

### Reach Boom 5.7 m

### VA Boom

Stick	Reach Boom 5.7 m		VA Boom	
	R2.9B1	R2.5B1	R2.9B1	R2.5B1
1 Maximum Digging Depth	6720 mm	6290 mm	6680 mm	6270 mm
2 Maximum Reach at Ground Level	9860 mm	9450 mm	10 200 mm	9800 mm
3 Maximum Cutting Height	9370 mm	9240 mm	11 520 mm	11 180 mm
4 Maximum Loading Height	6490 mm	6300 mm	8410 mm	8070 mm
5 Minimum Loading Height	2170 mm	2600 mm	3270 mm	3670 mm
6 Maximum Depth Cut for 2440 mm Level Bottom	6550 mm	6100 mm	6580 mm	6170 mm
7 Maximum Vertical Wall Digging Depth	5060 mm	5210 mm	5290 mm	4890 mm
Bucket Capacity	1.19 m <sup>3</sup>	1.3 m <sup>3</sup>	1.3 m <sup>3</sup>	1.3 m <sup>3</sup>
Bucket Tip Radius	1570 mm	1560 mm	1560 mm	1560 mm



# 323E L/LN Hydraulic Excavator Specifications

## 323E LN Working Ranges

All dimensions are approximate.

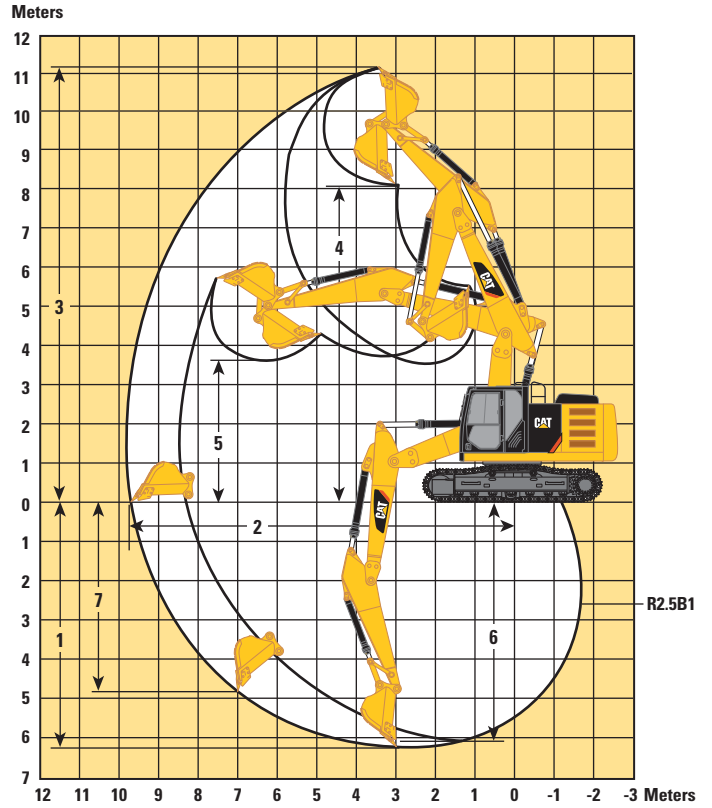
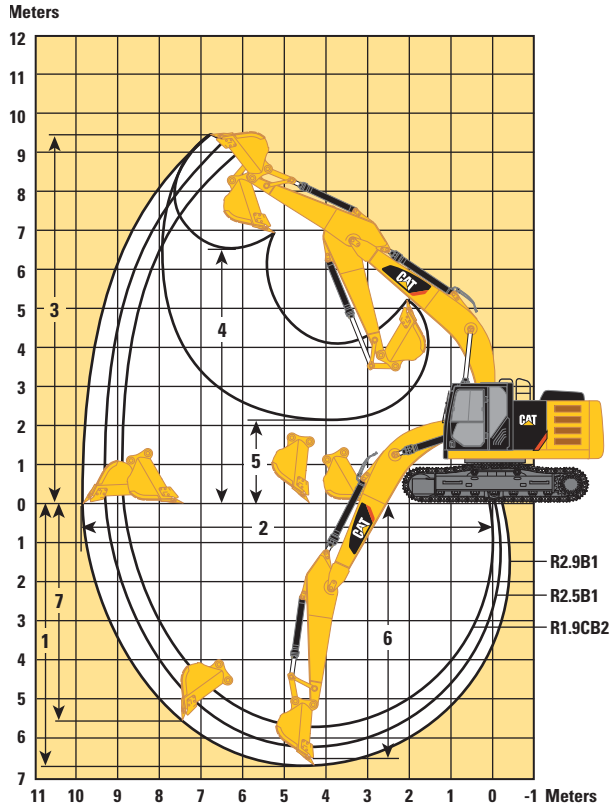

Stick	Reach Boom 5.7 m			VA Boom
	R2.9B1	R2.5B1	R1.9CB2	R2.5B1
1 Maximum Digging Depth	6710 mm	6290 mm	5760 mm	6270 mm
2 Maximum Reach at Ground Level	9850 mm	9450 mm	8950 mm	9800 mm
3 Maximum Cutting Height	9450 mm	9240 mm	8940 mm	11 180 mm
4 Maximum Loading Height	6500 mm	6300 mm	5930 mm	8070 mm
5 Minimum Loading Height	2180 mm	2600 mm	3150 mm	3670 mm
6 Maximum Depth Cut for 2440 mm Level Bottom	6540 mm	6100 mm	5520 mm	6170 mm
7 Maximum Vertical Wall Digging Depth	5610 mm	5210 mm	4360 mm	4890 mm
Bucket Capacity	1.3 m <sup>3</sup>	1.3 m <sup>3</sup>	1.3 m <sup>3</sup>	1.3 m <sup>3</sup>
Bucket Tip Radius	1560 mm	1560 mm	1620 mm	1560 mm

# 323E L/LN Hydraulic Excavator Specifications

## 323E L Operating Weight and Ground Pressure\*

	900 mm		790 mm		700 mm		600 mm	
	Triple Grouser Shoes	Triple Grouser Shoes	Triple Grouser Shoes	Triple Grouser Shoes	Triple Grouser Shoes	Triple Grouser Shoes	Triple Grouser Shoes	Triple Grouser Shoes
	kg	kPa	kg	kPa	kg	kPa	kg	kPa
Reach Boom ES – 5.7 m								
R2.9B1 ES	23 400	32.4	23 300	36.7	23 000	40.9	22 600	47.0
Reach Boom HD – 5.7 m								
R2.9B1 ES	24 100	33.4	23 800	37.6	23 500	41.8	23 200	48.2
R2.5B1 ES	23 800	33.0	23 500	37.1	23 200	41.3	22 900	47.6
VA Boom								
R2.9B1 ES	25 200	34.9	24 900	39.3	26 400	43.8	24 300	50.5
R2.5B1 HD	25 000	34.6	24 700	39.0	24 400	43.4	24 100	50.1

\*Actual weights will depend on final configuration.

## 323E L Major Component Weights

	kg
Base Machine (with boom cylinder, without counterweight, front linkage and track)	11 300
Long Undercarriage	7850
Counterweight	
4.1 mt	4100
Boom (includes lines, pins and stick cylinder)	
Reach Boom HD – 5.7 m	1720
Reach Boom ES – 5.7 m	2010
VA Boom	2580
Stick (includes lines, pins and bucket cylinder)	
R2.9B1 ES	840
R2.5B1 HD	670
R2.5B1 ES	770
Track Shoe (Long/per two tracks)	
600 mm Triple Grouser	2700
600 mm Triple Grouser HD	3100
700 mm Triple Grouser HD	3510
790 mm Triple Grouser	3360
900 mm Triple Grouser	3640

All weights are rounded up to nearest 10 kg except for buckets. Kg was rounded up separately so some of the kg do not match.

Base machine includes 75 kg operator weight, 90% fuel weight, and undercarriage with center guard.



# 323E L/LN Hydraulic Excavator Specifications

## 323E LN Operating Weight and Ground Pressure\*

	500 mm Triple Grouser Shoes	
	kg	kPa
Reach Boom HD – 5.7 m		
R2.9B1 ES	23 280	68.9
R2.5B1 ES	23 170	68.6
R1.9CB2 HD	23 180	68.6
Reach Boom ES – 5.7 m		
R2.5B1 ES	23 460	69.4
VA Boom		
R2.5B1 ES	24 230	71.4

\*Actual weights will depend on final configuration.

## 323E LN Major Component Weights

	kg
Base Machine (with boom cylinder, without counterweight, front linkage and track)	11 450
Long Undercarriage with 500 mm Triple Grouser	6880
Counterweight	
4.4 mt	4400
Boom (includes lines, pins and stick cylinder)	
Reach Boom HD – 5.7 m	1720
Reach Boom ES – 5.7 m	2010
VA Boom	2580
Stick (includes lines, pins and bucket cylinder)	
R2.5B1 ES	770
R1.9CB2 HD	740
R2.9B1 ES	840
Track Shoe (Long/per two tracks)	
500 mm Triple Grouser	2440

All weights are rounded up to nearest 10 kg except for buckets. Kg was rounded up separately so some of the kg do not match.

Base machine includes 75 kg operator weight, 90% fuel weight, and undercarriage with center guard.

# 323E L/LN Hydraulic Excavator Specifications

## 323E L Bucket and Stick Forces

Stick	Reach Boom 5.7 m					
	B1-Family Bucket		B1-Family Bucket for CW-40		B1-Family Bucket for CW-40S	
	R2.9B1 kN	R2.5B1 kN	R2.9B1 kN	R2.5B1 kN	R2.9B1 kN	R2.5B1 kN
General Duty						
Bucket Digging Force (ISO)	140.5	140.5	127.7	127.7	127.7	127.7
Stick Digging Force (ISO)	106.7	118.2	103.2	114.0	103.2	114.0
Heavy Duty						
Bucket Digging Force (ISO)	150.4	140.2	127.4	127.4	127.4	127.4
Stick Digging Force (ISO)	106.4	118.1	103.1	113.8	103.1	113.8
Severe Duty						
Bucket Digging Force (ISO)	150.4	–	–	–	–	–
Stick Digging Force (ISO)	106.4	–	–	–	–	–



# 323E L/LN Hydraulic Excavator Specifications

## 323E LN Bucket and Stick Forces

Stick	Reach Boom 5.7 m								
	B1-Family Bucket			B1-Family Bucket for CW-40			B1-Family Bucket for CW-40S		
	R2.9B1 <sup>1</sup>	R2.5B1 <sup>1</sup>	R1.9CB2 <sup>2</sup>	R2.9B1 <sup>1</sup>	R2.5B1 <sup>1</sup>	R1.9CB2 <sup>2</sup>	R2.9B1 <sup>1</sup>	R2.5B1 <sup>1</sup>	R1.9CB2 <sup>2</sup>
	kN	kN	kN	kN	kN	kN	kN	kN	kN
General Duty									
Bucket Digging Force (ISO)	140.5	140.5	178.9	127.7	127.7	162.87	127.7	127.7	–
Stick Digging Force (ISO)	106.7	118.2	147.9	103.2	114.0	140.6	103.2	114.0	–
General Duty Capacity									
Bucket Digging Force (ISO)	139.4	139.4	174.1	–	–	–	–	–	–
Stick Digging Force (ISO)	106.2	117.7	145.5	–	–	–	–	–	–
Heavy Duty									
Bucket Digging Force (ISO)	140.2	140.2	178.7	127.4	127.4	–	127.4	127.4	171.78
Stick Digging Force (ISO)	106.6	118.1	147.8	103.1	113.8	–	103.1	113.8	144.78
Heavy Duty Power									
Bucket Digging Force (ISO)	–	–	194.9	–	–	–	–	–	–
Stick Digging Force (ISO)	–	–	149.7	–	–	–	–	–	–
Severe Duty									
Bucket Digging Force (ISO)	–	–	178.5	–	–	–	–	–	–
Stick Digging Force (ISO)	–	–	147.7	–	–	–	–	–	–

<sup>1</sup>B1-Family Bucket

<sup>2</sup>CB2-Family Bucket

## 323E LN Bucket and Stick Forces

Stick	VA Boom		
	B1-Family Bucket	B1-Family Bucket for CW-40	B1-Family Bucket for CW-40S
	R2.5B1	R2.5B1	R2.5B1
	kN	kN	kN
General Duty			
Bucket Digging Force (ISO)	140.5	127.7	127.7
Stick Digging Force (ISO)	118.2	114.0	114.0
General Duty Capacity			
Bucket Digging Force (ISO)	139.4	–	–
Stick Digging Force (ISO)	117.7	–	–
Heavy Duty			
Bucket Digging Force (ISO)	140.2	127.4	127.4
Stick Digging Force (ISO)	118.1	113.8	113.8

# 323E L/LN Hydraulic Excavator Specifications

## 323E L Reach Boom HD Lift Capacities – Counterweight: 4.1 mt – without Bucket

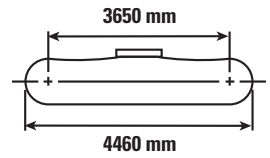
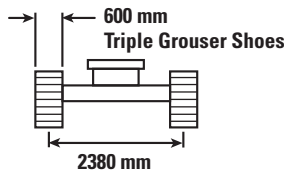
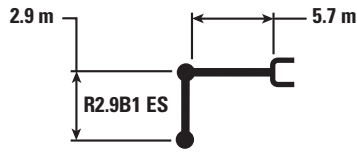

Reach (m)	Unit	1.5 m		3.0 m		4.5 m		6.0 m		7.5 m		m		
		Hydraulic	Tipping	Hydraulic	Tipping	Hydraulic	Tipping	Hydraulic	Tipping	Hydraulic	Tipping	Hydraulic	Tipping	
7.5 m	kg							*4900	*4900			*4200	*4200	6.15
6.0 m	kg							*5350	*5350			*3900	*3900	7.28
4.5 m	kg							*5900	5400	*5550	3800	*3850	3450	7.98
3.0 m	kg					*8650	7850	*6800	5150	5750	3700	*3900	3150	8.35
1.5 m	kg					*10 450	7350	*7700	4900	5600	3600	*4150	3000	8.44
0 m	kg			*6550	*6550	*11 500	7050	7650	4750	5500	3500	*4600	3050	8.26
-1.5 m	kg	*7000	*7000	*11 350	*11 350	*11 600	7000	7550	4650	5450	3450	5200	3300	7.78
-3.0 m	kg	*12 000	*12 000	*15 400	13 650	*10 850	7050	7600	4700			6150	3900	6.94
-4.5 m	kg			*12 300	*12 300	*8800	7250					*6650	5350	5.60



ISO 10567



\*Indicates that the load is limited by hydraulic lifting capacity rather than tipping load. The above loads are in compliance with hydraulic excavator lift capacity standard ISO 10567:2007. They do not exceed 87% of hydraulic lifting capacity or 75% of tipping load. Weight of all lifting accessories must be deducted from the above lifting capacities. Lifting capacities are based on the machine standing on a firm, uniform supporting surface. The use of a work tool attachment point to handle/lift objects, could affect the machine lift performance.

Lift capacity stays with  $\pm 5\%$  for all available track shoes.









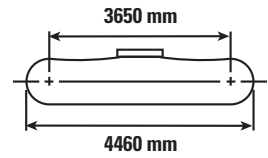
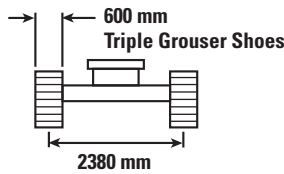
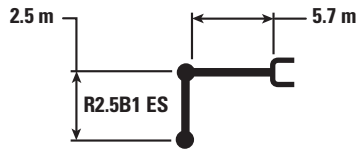

Always refer to the appropriate Operation and Maintenance Manual for specific product information.



# 323E L/LN Hydraulic Excavator Specifications

## 323E L Reach Boom HD Lift Capacities – Counterweight: 4.1 mt – without Bucket



		3.0 m		4.5 m		6.0 m		7.5 m				m
												
7.5 m	kg									*5150	*5150	5.59
6.0 m	kg					*5900	5650			*4750	4550	6.83
4.5 m	kg			*7400	*7400	*6400	5500	*5200	3900	*4650	3850	7.57
3.0 m	kg			*9350	7950	*7250	5300	5900	3850	*4750	3500	7.96
1.5 m	kg			*11 050	7500	8000	5050	5800	3750	*5050	3400	8.05
0 m	kg			*11 800	7300	7850	4900	5700	3650	5350	3450	7.86
-1.5 m	kg	*12 000	*12 000	*11 650	7250	7800	4900			5850	3750	7.35
-3.0 m	kg	*14 600	14 200	*10 600	7350	*7850	4950			*7000	4500	6.46
-4.5 m	kg			*7950	7600					*6900	6600	4.98



ISO 10567



\*Indicates that the load is limited by hydraulic lifting capacity rather than tipping load. The above loads are in compliance with hydraulic excavator lift capacity standard ISO 10567:2007. They do not exceed 87% of hydraulic lifting capacity or 75% of tipping load. Weight of all lifting accessories must be deducted from the above lifting capacities. Lifting capacities are based on the machine standing on a firm, uniform supporting surface. The use of a work tool attachment point to handle/lift objects, could affect the machine lift performance.

Lift capacity stays with  $\pm 5\%$  for all available track shoes.

Always refer to the appropriate Operation and Maintenance Manual for specific product information.

# 323E L/LN Hydraulic Excavator Specifications

## 323E L Reach Boom ES Lift Capacities – Counterweight: 4.1 mt – without Bucket

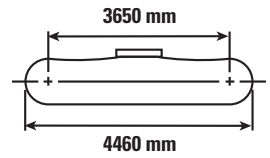
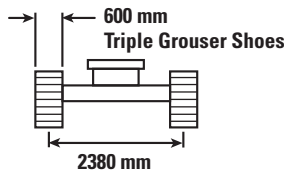
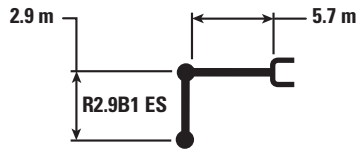

Reach (m)	Unit	1.5 m		3.0 m		4.5 m		6.0 m		7.5 m		m		
		Hydraulic	Tipping	Hydraulic	Tipping	Hydraulic	Tipping	Hydraulic	Tipping	Hydraulic	Tipping	Hydraulic	Tipping	
7.5 m	kg							*4900	*4900			*4200	*4200	6.15
6.0 m	kg							*5300	*5300			*3900	*3900	7.28
4.5 m	kg							*5850	5400	*5450	3750	*3850	3400	7.98
3.0 m	kg					*8550	7800	*6700	5100	5700	3650	*3900	3100	8.35
1.5 m	kg					*10 300	7250	*7600	4850	5550	3550	*4150	2950	8.44
0 m	kg			*6550	*6550	*11 300	6950	7550	4650	5450	3450	*4600	3000	8.26
-1.5 m	kg	*7000	*7000	*11 350	*11 350	*11 400	6850	7450	4550	5400	3400	5150	3250	7.78
-3.0 m	kg	*12 000	*12 000	*15 150	13 400	*10 650	6900	7500	4600			6100	3800	6.94
-4.5 m	kg			*12 050	*12 050	*8650	7150					*6550	5300	5.60



ISO 10567



\*Indicates that the load is limited by hydraulic lifting capacity rather than tipping load. The above loads are in compliance with hydraulic excavator lift capacity standard ISO 10567:2007. They do not exceed 87% of hydraulic lifting capacity or 75% of tipping load. Weight of all lifting accessories must be deducted from the above lifting capacities. Lifting capacities are based on the machine standing on a firm, uniform supporting surface. The use of a work tool attachment point to handle/lift objects, could affect the machine lift performance.

Lift capacity stays with  $\pm 5\%$  for all available track shoes.

Always refer to the appropriate Operation and Maintenance Manual for specific product information.



# 323E L/LN Hydraulic Excavator Specifications

## 323E L Variable Angle Boom Lift Capacities – Counterweight: 4.1 mt – without Bucket

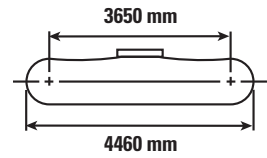
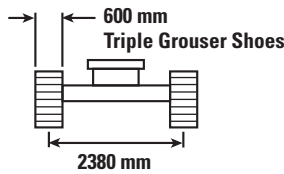
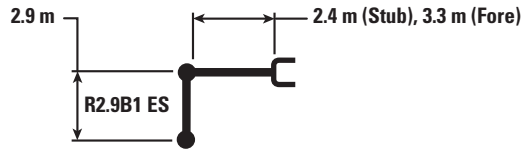

Reach (m)	Unit	1.5 m		3.0 m		4.5 m		6.0 m		7.5 m		m		
		Diagram	Diagram	Diagram	Diagram	Diagram	Diagram	Diagram	Diagram	Diagram	Diagram	Diagram	Diagram	
9.0 m	kg					*5400	*5400					*5450	*5450	4.88
7.5 m	kg					*7400	*7400	*4600	*4600			*4650	*4650	6.61
6.0 m	kg					*7500	*7500	*5250	*5250	*4400	3800	*4350	3650	7.68
4.5 m	kg			*11 650	*11 650	*7300	*7300	*5250	*5250	*4450	3750	*4250	3100	8.35
3.0 m	kg			*11 150	*11 150	*7100	*7100	*5200	5050	*4700	3650	*4300	2850	8.70
1.5 m	kg			*6600	*6600	*7650	7100	*5850	4800	*5250	3500	4400	2750	8.79
0 m	kg	*7350	*7350	*6000	*6000	*9950	6850	*6800	4600	5450	3400	4500	2800	8.61
-1.5 m	kg	*9050	*9050	*9300	*9300	*11 350	6750	7450	4500	5400	3350	4850	3000	8.15
-3.0 m	kg	*14 300	*14 300	*12 950	*12 950	*8950	6850	*6950	4550			*4850	3500	7.34
-4.5 m	kg	*22 350	*22 350	*13 200	*13 200	*8400	7100					*7000	5550	5.35



ISO 10567



\*Indicates that the load is limited by hydraulic lifting capacity rather than tipping load. The above loads are in compliance with hydraulic excavator lift capacity standard ISO 10567:2007. They do not exceed 87% of hydraulic lifting capacity or 75% of tipping load. Weight of all lifting accessories must be deducted from the above lifting capacities. Lifting capacities are based on the machine standing on a firm, uniform supporting surface. The use of a work tool attachment point to handle/lift objects, could affect the machine lift performance.

Lift capacity stays with  $\pm 5\%$  for all available track shoes.

Always refer to the appropriate Operation and Maintenance Manual for specific product information.

# 323E L/LN Hydraulic Excavator Specifications

## 323E L Variable Angle Boom Lift Capacities – Counterweight: 4.1 mt – without Bucket

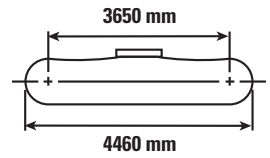
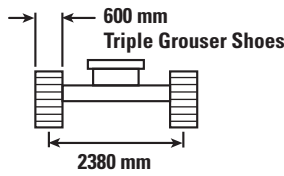
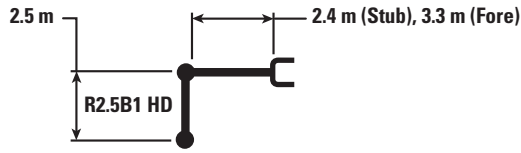

Reach (m)	Unit	1.5 m		3.0 m		4.5 m		6.0 m		7.5 m		m		
		Diagram	Diagram	Diagram	Diagram	Diagram	Diagram	Diagram	Diagram	Diagram	Diagram	Diagram	Diagram	
9.0 m	kg											*6700	*6700	4.10
7.5 m	kg					*7600	*7600	*5600	5550			*5500	5400	6.07
6.0 m	kg					*7600	*7600	*5200	*5200			*5050	4050	7.22
4.5 m	kg			*11 600	*11 600	*7450	*7450	*5050	*5050	*5100	3800	*4950	3450	7.92
3.0 m	kg			*10 200	*10 200	*7300	*7300	*5500	5100	*5350	3700	4900	3150	8.30
1.5 m	kg			*7450	*7450	*8250	7150	*6200	4850	5650	3550	4800	3050	8.39
0 m	kg	*10 200	*10 200	*6700	*6700	*10 700	6950	*7200	4700	5550	3500	4900	3100	8.20
-1.5 m	kg	*11 300	*11 300	*10 250	*10 250	*10 750	6950	7600	4650	5550	3500	5350	3350	7.72
-3.0 m	kg	*17 550	*17 550	*13 250	*13 250	*8450	7050	*6300	4700			*5450	4050	6.76
-4.5 m	kg	*24 300	*24 300	*13 450	*13 450							*9450	8350	4.14



ISO 10567



\*Indicates that the load is limited by hydraulic lifting capacity rather than tipping load. The above loads are in compliance with hydraulic excavator lift capacity standard ISO 10567:2007. They do not exceed 87% of hydraulic lifting capacity or 75% of tipping load. Weight of all lifting accessories must be deducted from the above lifting capacities. Lifting capacities are based on the machine standing on a firm, uniform supporting surface. The use of a work tool attachment point to handle/lift objects, could affect the machine lift performance.

Lift capacity stays with  $\pm 5\%$  for all available track shoes.

Always refer to the appropriate Operation and Maintenance Manual for specific product information.

# 323E L/LN Hydraulic Excavator Specifications

## 323E L Work Tool Offering Guide\*

Boom Type	Reach HD		Reach ES	VA Boom	
Stick Size	R2.9B1 ES	R2.5B1 ES	R2.9B1 ES	R2.9B1 ES	R2.5B1 HD
Hydraulic Hammer	H115Es H120Es H130Es	H115Es H120Es H130Es	H115Es H120Es H130Es	H115Es H120Es H130Es	H115Es H120Es H130Es
Multi-Processor	MP15**^	MP15	MP15**^	MP15**^	MP15^^
Crusher	P315**	P315	P315**	P315**	P315
Pulverizer	P215	P215	P215	P215	P215
Demolition and Sorting Grapple	G315B**	G315B G320B***	G315B**	G315B**	G315B G320B***#
Mobile Scrap and Demolition Shear	S320B*** S325B## S340B###	S320B S325B## S340B###	S320B*** S325B##	S320B*** S325B##	S320B** S325B##
Compactor (Vibratory Plate)	CVP110	CVP110	CVP110	CVP110	CVP110
Contractors' Grapple	G120B-G130B	G120B-G130B	G120B-G130B	G120B-G130B	G120B-G130B
Trash Grapple	These work tools are available for the 323E L. Consult your Cat dealer for proper match.				
Orange Peel Grapples					
Dedicated Quick Coupler					

\*Matches are dependent on excavator configurations. Consult your Cat dealer for proper work tool match.

\*\*Pin-on or CW coupler.

\*\*\*Pin-on only.

#Over the front only.

##Boom mount.

^PP jaws pin-on only.

^^PP jaws over the front only with CL quick coupler.

## 323E LN Work Tool Offering Guide\*

Boom Type	Reach HD		Reach ES	VA Boom	
Stick Size	R2.9B1 ES	R2.5B1 ES	R1.9CB2 HD	R2.5B1 ES	R2.5B1 ES
Hydraulic Hammer	H115Es H120Es H130Es	H115Es H120Es H130Es	H120Es H130Es H140Ds**^^	H115Es H120Es H130Es	H115Es H120Es H130Es^
Multi-Processor	MP15 CC Jaw** MP15 CR Jaw** MP15 PP Jaw*** MP15 PS Jaw** MP15 S Jaw**	MP15 CC Jaw MP15 CR Jaw MP15 PP Jaw** MP15 PS Jaw^ MP15 S Jaw	MP15 CC Jaw^ MP15 CR Jaw MP15 PP Jaw MP15 PS Jaw^ MP15 S Jaw	MP15 CC Jaw^ MP15 CR Jaw^ MP15 PP Jaw***^ MP15 PS Jaw^ MP15 S Jaw^	MP15 CC Jaw** MP15 CR Jaw** MP15 PP Jaw***# MP15 PS Jaw***^ MP15 S Jaw**
Crusher	P315**	P315**	P315**	P315**	P315***
Pulverizer	P215	P215	P215	P215	P215**
Demolition and Sorting Grapple	G315B**	G315B**		G315B**	G315B**
Mobile Scrap and Demolition Shear	S320B*** S325B##	S320B^ S325B##	S320B** S325B##	S320B** S325B##	S320B***^ S325B##
Compactor (Vibratory Plate)	CVP110	CVP110	CVP110	CVP110	CVP110
Contractors' Grapple	G120B-G130B	G120B-G130B	G120B-G130B	G120B-G130B	G120B-G130B
Trash Grapple	These work tools are available for the 323E LN. Consult your Cat dealer for proper match.				
Orange Peel Grapples					
Dedicated Quick Coupler					

\*Matches are dependent on excavator configurations. Consult your Cat dealer for proper work tool match.

\*\*Pin-on or CW coupler.

\*\*\*Pin-on only.

#Over the front only.

##Boom mount.

^Over the front only with the CL coupler.

^^Over the front only with the CW coupler.



# 323E L/LN Hydraulic Excavator Specifications

## 323E L Bucket Specifications and Compatibility

	Linkage	Width	Capacity	Weight	Fill	Reach Boom (HD)		Reach Boom (ES)	VA Boom	
		mm	m <sup>3</sup>	kg	%	R2.9 ES	R2.5 ES	R2.9 ES	R2.9 ES	R2.5 HD
<b>Without Quick Coupler</b>										
General Duty (GD)	B	600	0.46	549	100%	●	●	●	●	●
	B	750	0.64	620	100%	●	●	●	●	●
	B	900	0.81	666	100%	●	●	●	●	●
	B	1200	1.19	800	100%	●	●	⊙	⊙	●
	B	1300	1.30	832	100%	⊙	⊙	⊙	⊙	●
	B	1400	1.43	867	100%	⊖	⊙	⊖	⊖	⊙
Heavy Duty (HD)	B	1050	1.00	879	100%	●	●	●	●	●
	B	1200	1.19	906	100%	⊙	●	⊙	⊙	●
	B	1200	1.19	917	100%	⊙	●	⊙	⊙	●
	B	1300	1.30	960	100%	⊙	⊙	⊖	⊖	⊙
Severe Duty (SD)	B	1200	1.19	1000	90%	●	●	●	⊙	●
Maximum load pin-on (payload + bucket)					kg	3240	3520	3160	3135	3490
<b>With Quick Coupler (CW40, CW40s)</b>										
General Duty (GD)	B	600	0.46	502	100%	●	●	●	●	●
	B	750	0.64	587	100%	●	●	●	●	●
	B	900	0.81	653	100%	●	●	●	●	●
	B	1200	1.19	767	100%	⊙	●	⊙	⊙	●
	B	1300	1.30	798	100%	⊖	⊙	⊖	⊖	⊙
	B	1400	1.43	834	100%	⊖	⊖	⊖	⊖	⊖
Heavy Duty (HD)	B	600	0.46	584	100%	●	●	●	●	●
	B	1200	1.19	873	100%	⊙	●	⊖	⊖	⊙
	B	1300	1.30	927	100%	⊖	⊙	⊖	⊖	⊙
Severe Duty (SD)	B	1200	1.19	984	90%	⊙	●	⊙	⊙	●
Maximum load with coupler (payload + bucket)					kg	2988	3268	2908	2883	3238

The above loads are in compliance with hydraulic excavator standard EN474, they do not exceed 87% of hydraulic lifting capacity or 75% of tipping capacity with front linkage fully extended at ground line with bucket curled.

Capacity based on ISO 7451.

Bucket weight with General Duty tips.

### Maximum Material Density:

- 2100 kg/m<sup>3</sup>
- ⊙ 1800 kg/m<sup>3</sup>
- ⊖ 1500 kg/m<sup>3</sup>

Caterpillar recommends using appropriate work tools to maximize the value customers receive from our products. Use of work tools, including buckets, which are outside of Caterpillar's recommendations or specifications for weight, dimensions, flows, pressures, etc. may result in less-than-optimal performance, including but not limited to reductions in production, stability, reliability, and component durability. Improper use of a work tool resulting in sweeping, prying, twisting and/or catching of heavy loads will reduce the life of the boom and stick.

# 323E L/LN Hydraulic Excavator Specifications

## 323E LN Bucket Specifications and Compatibility

	Linkage	Width	Capacity	Weight	Fill	Reach Boom			Reach Boom (HD)	VA Boom
		mm	m <sup>3</sup>	kg	%	R2.9 HD	R2.5 HD	R1.9 CB	R2.5 HD	R2.5 HD
<b>Without Quick Coupler</b>										
General Duty (GD)	B	600	0.46	549	100%	☉	☉		☉	☉
	B	750	0.64	620	100%	☉	☉		☉	☉
	B	900	0.81	666	100%	☉	☉		☉	☉
	B	1200	1.19	800	100%	☹	☉		☉	☉
	B	1300	1.30	832	100%	☹	☹		☹	☹
	B	1400	1.43	867	100%	○	☹		○	○
	CB	750	0.71	730	100%			☉		
	CB	1050	1.12	864	100%			☉		
	CB	1200	1.33	927	100%			☹		
	CB	1350	1.54	1009	100%			○		
Heavy Duty (HD)	B	1200	1.19	906	100%	☹	☉		☹	☹
	B	1300	1.30	960	100%	○	☹		☹	☹
	CB	1350	1.54	1134	100%			○		
	CB	1500	1.76	1229	100%			◇		
Severe Duty (SD)	B	1200	1.19	1000	90%	☹	☉		☉	☉
	CB	1350	1.56	1245	90%			○		
Maximum load pin-on (payload + bucket)					kg	2720	2965	3190	2870	2865
<b>With Quick Coupler (CW40, CW40s)</b>										
General Duty (GD)	B	900	0.81	653	100%	☉	☉		☉	☉
	B	1050	1.00	705	100%	☉	☉		☉	☉
	B	1200	1.19	767	100%	☹	☹		☹	☹
	B	1300	1.30	798	100%	○	☹		○	○
	CB	750	0.71	693	100%			☉		
	CB	900	0.91	730	100%			☉		
	CB	1050	1.12	805	100%			☉		
	CB	1200	1.33	869	100%			☹		
	CB	1350	1.54	1008	100%			○		
	CB	1500	1.76	1073	100%			◇		
Heavy Duty (HD)	B	600	0.46	584	100%	☉	☉		☉	☉
	B	750	0.64	670	100%	☉	☉		☉	☉
	B	1050	1.00	815	100%	☹	☉		☉	☉
	B	1200	1.19	873	100%	○	☹		☹	☹
	B	1300	1.30	927	100%	○	○		○	○
	CB	750	0.71	736	100%			☉		
	CB	1050	1.12	954	100%			☉		
	CB	1350	1.54	1076	100%			○		
Severe Duty (SD)	B	1200	1.19	984	90%	○	☹		☹	☹
	CB	1050	1.13	987	90%			☉		
	CB	1350	1.56	1155	90%			○		
Maximum load with coupler (payload + bucket)					kg	2468	2713	2938	2618	2613

### Maximum Material Density:

- ☉ 1800 kg/m<sup>3</sup>
- ☹ 1500 kg/m<sup>3</sup>
- 1200 kg/m<sup>3</sup>
- ◇ 900 kg/m<sup>3</sup>

The above loads are in compliance with hydraulic excavator standard EN474, they do not exceed 87% of hydraulic lifting capacity or 75% of tipping capacity with front linkage fully extended at ground line with bucket curled.

Capacity based on ISO 7451.

Bucket weight with General Duty tips.

Caterpillar recommends using appropriate work tools to maximize the value customers receive from our products. Use of work tools, including buckets, which are outside of Caterpillar's recommendations or specifications for weight, dimensions, flows, pressures, etc. may result in less-than-optimal performance, including but not limited to reductions in production, stability, reliability, and component durability. Improper use of a work tool resulting in sweeping, prying, twisting and/or catching of heavy loads will reduce the life of the boom and stick.

# 323E L/LN Standard Equipment

## Standard Equipment

Standard equipment may vary. Consult your Cat dealer for details.

### ENGINE

- C6.6 diesel engine
- Biodiesel capable
- European Union Stage IIIB compliant
- 2300 m altitude capability
- Electric priming pump (lifting pump)
- Automatic engine speed control
- Economy and high power modes
- Two-speed travel
- Side-by-side cooling system (tilt-up ATAAC, swing-out A/C condenser)
- Radial seal air filter
- Primary filter with water separator and water separator indicator switch
- Battery standard, -18° C
- Screen fuel filter in fuel lines
- Primary fuel filter
- Secondary fuel filter

### HYDRAULIC SYSTEM

- Regeneration circuit for boom and stick
- Reverse swing dampening valve
- Automatic swing parking brake
- High-performance hydraulic return filter
- Capability of installing HP stackable valve and medium and QC valve
- Capability of installing additional auxiliary pump and circuit
- Capability of installing boom lowering control device and stick lowering check valve
- Capability of installing Cat Bio hydraulic oil
- Quick drains, engine and hydraulic oil (QuickEvac) – unavailable for 323E LN

### CAB

- Pressurized operator station with positive filtration
- Mirror package
- Sliding upper door window (left-hand cab door)
- Glass-breaking safety hammer
- Removable lower windshield with in cab storage bracket
- Coat hook
- Beverage holder
- Literature holder
- Two 12V stereo speakers
- Storage shelf suitable for lunch or toolbox
- Color LCD display with warning, filter/fluid change, and working hour information
- Adjustable armrest
- Height adjustable joystick consoles
- Neutral lever (lock out) for all controls
- Travel control pedals with removable hand levers
- Capability of installing two additional pedals
- Two power outlets, 10 amp (total)
- Laminated glass front upper window and tempered other windows
- Sunscreen
- Windshield wiper, lower with washer

### UNDERCARRIAGE

- Grease Lubricated Track GLT2, resin seal
- Towing eye on base frame
- Heavy-duty travel motor guards

### ELECTRICAL

- 80 amp alternator
- Circuit breaker
- Capability to electrically connect a beacon

### LIGHTS

- Boom light with time delay
- Exterior lights integrated into storage box

### SECURITY

- Cat one key security system
- Door locks
- Cap locks on fuel and hydraulic tanks
- Lockable external tool/storage box
- Signaling/warning horn
- Secondary engine shutoff switch
- Openable skylight for emergency exit
- Rearview camera

### TECHNOLOGY

- Product Link
- Cat Grade Control Depth and Slope



## Optional Equipment

Optional equipment may vary. Consult your Cat dealer for details.

### ENGINE

- Electric refueling pump with auto shut off
- Cold weather battery, -32° C
- Radiator screen

### HYDRAULIC SYSTEM

- Additional circuit
- Boom and stick lines
- High-pressure line
- Medium-pressure line
- Cat quick coupler line – high- and medium-pressure capable
- Electronic Control device, 1/2P, one-way circuit
- Electronic Control device (Common), 1/2P, common circuit

### CAB

- Seat, high-back air suspension with heater
- Seat, high-back air suspension with heater and cooling
- Seat, high-back mechanical suspension
- Air pre-filter
- Left foot switch
- Straight travel pedal
- Rain protector

### UNDERCARRIAGE

- Long narrow undercarriage
  - 500 mm triple grouser shoes (LN)
- Long undercarriage
  - 600 mm triple grouser shoes and HD
  - 700 mm triple grouser shoes HD
  - 790 mm triple grouser shoes
  - 900 mm triple grouser shoes
- Full length track guiding guard
- Center track guiding guard
- Segmented (2 piece) track guiding guard

### FRONT LINKAGE

- Quick coupler
- Bucket linkage, B1 family with and without lifting eye
- Bucket linkage, CB2 family with lifting eye
- Reach Boom 5.7 m
  - 2.9 m Extreme Service stick
  - 2.5 m Heavy Duty and Extreme Service sticks
- VA boom
  - 2.9 m Extreme Service stick
  - 2.5 m Heavy Duty and Extreme Service sticks
  - 1.9 m Heavy Duty stick

### LIGHTS

- Working lights, cab mounted with time delay
- HID lights, cab mounted with time delay

### SECURITY

- FOGS, bolt-on
- Travel alarm

For more complete information on Cat products, dealer services, and industry solutions, visit us on the web at [www.cat.com](http://www.cat.com)

© 2014 Caterpillar  
All rights reserved

Materials and specifications are subject to change without notice. Featured machines in photos may include additional equipment. See your Cat dealer for available options.

CAT, CATERPILLAR, SAFETY.CAT.COM, their respective logos, "Caterpillar Yellow" and the "Power Edge" trade dress, as well as corporate and product identity used herein, are trademarks of Caterpillar and may not be used without permission.

VisionLink is a trademark of Trimble Navigation Limited, registered in the United States and in other countries.

AEHQ6581-03 (11-2014)  
Replaces AEHQ6581-02  
(EU)

